

INW Roots blowers Operating Instructions



INECO

**Air and Vacuum
Components**

www.in-eco.eu

IN-ECO, spol. s r.o.
Radlinského 13, 034 01 Ružomberok, Slovak Republic
Telefón: +421/44/4304662, Fax: +421/44/4304663
www.in-eco.eu, e-mail: info@in-eco.sk

Contents

1 Safety	04
1.1 Definitions	04
1.2 Safety alert symbol	05
2 Principle of Roots Blower	06
3 Notice Of Operation and Maintenance	07
4 Installation	08
5 Operating Instruction	09
6 Operation trial	10
7 Safety valve adjustment	11
8 Maintenance	12
9 Troubleshooting	15
10 Construction and Spare Parts	17

1 Safety

1.1 Definitions

To point out dangers and important information, the following signal words and symbols are used in these operating instructions:

1.2 Safety alert symbol

The safety alert symbol is located in the safety precautions in the highlighted heading field on the left next to the signal word (DANGER, WARNING, CAUTION). Safety precautions with a safety alert symbol indicate a danger of injuries. Be sure to follow these safety precautions to protect against injuries or death! Safety precautions without a safety alert symbol indicate a danger of damage.

1.3 Signal words

DANGER
WARNING
CAUTION
NOTICE
NOTE

The signal words are located in the safety precautions in the highlighted heading field. They follow a certain hierarchy and indicate (in conjunction with the safety alert symbol, see Chapter 1.2) the seriousness of the danger and the type of warning.

See the following explanations:

⚠ DANGER	⚠ WARNING	⚠ CAUTION
Danger of injuries. Indicates an imminently hazardous situation, that will result in death or serious injury if the corresponding measures are not taken.	Danger of injuries. Indicates a potentially hazardous situation, that could result in death or serious injury if the corresponding measures are not taken.	Danger of injuries. Indicates a potentially hazardous situation, that may result in minor or moderate injury if the corresponding measures are not taken.
CAUTION	CAUTION	NOTICE
Danger of damage. Indicates a potentially hazardous situation that may result in property damage if the corresponding measures are not taken.	Danger of damage. Indicates a potentially hazardous situation that may result in property damage if the corresponding measures are not taken.	Indicates a possible disadvantage, i.e. undesirable conditions or consequences can occur if the corresponding measures are not taken.
⚠ WARNING	⚠ WARNING	NOTE
Improper use of the unit can result in serious or even fatal injuries! These operating instructions: > must have been read completely and understood before beginning any work with or at the pump-motor unit, > must be strictly observed, > must be available at the operating location of the pump-motor unit.	Improper use of the unit can result in serious or even fatal injuries! Transport and handling as well as assembly and disassembly of the unit may be carried out by trained and responsible personnel only!	Indicates a possible advantage if the corresponding measures are taken; tip.

	<p>⚠ WARNING</p>
<p>When working on the unit, there is a danger of injury, e.g. in the form of cuts/ cutting off, crushing and burns! During transport/handling as well as assembly and disassembly always wear personal protective equipment (safety helmet, protective gloves, safety boots)!</p>	

	<p>⚠ WARNING</p>
<p>Hair and clothing can be pulled into the unit or caught and wound up moving parts! Do not wear long, loose hair or wide, loose clothes! Use a hair net!</p>	



	<p>⚠ DANGER</p>
<p>Electrical danger! Before beginning work on the unit or system, the following measures must be carried out:</p> <ul style="list-style-type: none"> > Deenergize. > Secure against being switched on again. > Determine whether deenergized. > Ground and short-circuit. > Cover or block off adjacent energized parts. 	

	<p>⚠ DANGER</p>
	<p>Electrical danger! Work on electrical installations may be carried out by trained and authorized electricians only!</p>

	<p>⚠ CAUTION</p>
<p>Danger of unit tipping over! > Secure the pump-motor unit on the installation surface before putting into operation!</p>	

	<p>⚠ WARNING</p>
<p>Hazard: Long, loose hair can be drawn into external fan through fan guard grate, even with fan guard mounted!</p> <p>Protective measures: Wear hair net!</p>	

	<p>⚠ WARNING</p>
<p>Danger from rotating external fan of unit! Only operate the unit with the fan guard mounted!</p>	

 	<p>⚠ WARNING</p>
<p>Danger from rotating external fan of unit! Only operate the unit with the fan guard mounted!</p> <p>It is prohibited to remove the fan guard!</p>	

	<p>⚠ WARNING</p>
<p>Danger in the form of cuts or cutting off extremities on the impeller of the pump-motor unit! > Do not reach into the unit through open connections! > Do not insert objects into the unit through the openings!</p>	

	<p>⚠ WARNING</p>
<p>Danger due to gauge pressure and vacuum! > Check the connections of the pipe/hose connections for leaks!</p>	

	<p>⚠ WARNING</p>
<p>Danger due to gauge pressure and vacuum! Danger due to escaping fluid! Check the connections of the pipe/hose connections for leaks!</p>	

	<p>⚠ WARNING</p>
<p>Danger of burns and scalding from hot surfaces of the pumpmotor unit and from hot fluids! > Do not touch during operation! > Allow to cool after shut-down!</p>	

	<p>⚠ WARNING</p>
<p>Danger in the form of cuts or cutting off extremities on the impeller of the pump-motor unit! > Do not reach into the unit through open connections! > Do not insert objects into the unit through the openings!</p>	

	<p>⚠ WARNING</p>
<p>Danger zone: Hot surface. Hazard: Burns/scalding possible. Protective measures: Do not touch! Wear protective gloves!</p>	

2. Principle of Roots Blower



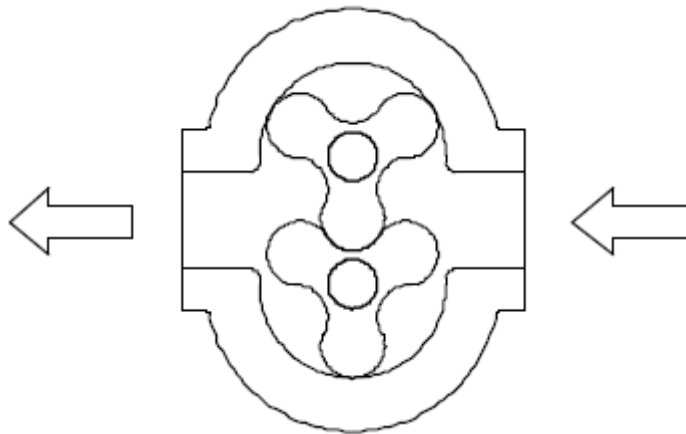

Roots Blower is a positive displacement machine, it can be used for blowing , it also can draw air like vacuum pump.

There are two lobes fixed on a set of synchromesh gear, the gap between two lobes, and the gap between lobes and the cylinder are very small. Since they do not touch each other, they do not need lubrication. Therefore, the transported air won't be polluted. Another advantage of no touch point is that the blower can run at high speed and draw more air.



Our product is very precise, and only bearing and gear need to be lubricated. The maintenance can reduce the damage of bearing and gear, and helps to maintain blower's life cycle.





3. Notice Of Operation and Maintenance

 WARNING	
   	<p>Danger due to gauge pressure and vacuum! Danger due to rotating parts!</p> <p>The pump-motor unit may only be put into operation when the following conditions are met:</p> <ul style="list-style-type: none"> - Fan guard and vacuum pump/compressor housing are mounted. - The lines and connections have been tested for strength and leaks.

- Ensure that cylinder is clean without any other things before operation.
- Ensure that installation and direction is correct.
- Inlet temperature should be under 50 degree C.
- Time of gear oil replacing
- Ensure that gear oil level is normal. (Please see page 12-13)
- Please use proper gear oil for lubrication. (Please see page 12-13)
- Make sure safety valve work is in normal (Please see page 11)
- Please refer to (page 14) for all types of bearing and coupling
- To order parts, please see page 17

 DANGER	
	<p>Electrical danger!</p> <p>Before beginning work on the unit or system, the following measures must be carried out:</p> <ul style="list-style-type: none"> - Deenergize. - Secure against being switched on again. - Determine whether deenergized. - Ground and short-circuit. - Cover or block off adjacent energized parts.

 DANGER	
	<p>Electrical danger!</p> <p>The electrical connection may be carried out by trained and authorized electricians only!</p>

4 Installation

- No need to make foundation base

There are 4 adjustable vibration isolators under the blower, they can keep blower steady on the ground without shaking. Therefore, it is no to make concrete foundation base.

- Movement

Please prevent the damage by collision or by shaking during the delivery. After moving, please check if the blower and its accessories are complete and the following check up is for your reference.

- (1) Check specification is same as purchase order when blower is arrived.
- (2) Check blower and screws are in good situation without damaged or loose.
- (3) Please lift / move blower with eye bolts which on blower.

- Installation and Adjustment

Before plumbing, please seal the inlet port and outlet port of blower well, so that foreign matter will not fall into the blower.



- Plumbing



(1) When plumbing, please pay attention for the followings to ensure the blower operates smoothly in the future.

(2) Please do not press pipes on the blower directly, so blower will not change its shape because heavy piping. The pipe which near the blower should be supported with suitable metal hanger ring or supporter. The central of pipe should be matched with central of blower, please do not tighten them forcedly. It would be better if add with a flexible joint, this can reduce the stress by deformed pipe and different temperature from piping.

(3) When the blower's inlet is opened, please put air filter to prevent anything to drop inside blower. Once they fall into the air cylinder, it will cause serious damages. When it is placed outdoor, please have a rain cover. Please add silencer on the inlet, outlet ports or pipe to reduce the noise. While conveyed air contains steam, it might congeal liquid during the process. Therefore, please have a drain hole at the bottom of plumbing.

- Greatech Silent Roots Blower is driven direct by coupling, it is no need to install pulley and belt. It is not only to save expense and time on belt changing, but also prevent pollution by waste belt powder.

 	⚠ WARNING
	<p>Danger from tipping or falling loads!</p> <p>Prior to transport and handling make sure that all components are securely assembled and secure or remove all components the fasteners of which have been loosened!</p>

  	⚠ CAUTION
	<p>Tipping or falling can lead to crushing, broken bones etc.! Sharp edges can cause cuts!</p> <p>Wear personal safety equipment (protective helmet, protective gloves, safety shoes) during transport!</p>

	⚠ WARNING
	<p>Danger from lifting heavy loads! Manual handling of the unit is only permitted within the following limits:</p> <ul style="list-style-type: none"> . max. 30 kg [max. 66 lbs] for men . max. 10 kg [max. 22 lbs] for women . max. 5 kg [max. 11 lbs] for pregnant women <p>For weights above the given values use suitable lifting appliances and handling equipment!</p>

5 Operating Instruction

- Preparation

(1) Make sure blower is on a horizontal plane, then start motor to check it can move easily. If there is any difficulty, please check the blower to see if it is out of shape by external force. The checking sequence is loosening the flange screws to adjust the opposition of itself, accessories and plumbing. Meanwhile, please check if there is any foreign material in the air cylinder.

(2) According to the manual to check the level of lubricating oil

(3) Check all the accessories are in the correct position and direction

(4) Open the control valve at inlet and outlet ports of the blower. The blower cannot be turned on while the valve is closed. There shall be the safety valves at inlet or outlet ports to protect the system and prevent the damages caused by wrong operation or resistance change from the system.

(5) Please install solenoid valve on power switch to prevent electric current overloading to damage motor.

*Special notice: Please check if the stop plate or sticker has been removed on flange of outlet.

	⚠ CAUTION
	<p>Danger of crushing from unit tipping over! In the unmounted state, the unit can easily tip due to its weight distribution! Wear gloves and safety shoes! Handle the unit with the appropriate care!</p>

	⚠ WARNING
	<p>Electrical danger! The pump-motor unit must be installed so that the electrical device cannot be damaged by external influences! In particular, the feed pipes must be securely routed, e.g. in cable ducts or in the floor.</p>

	⚠ CAUTION
	<p>Danger of damage to the pump-motor unit due to overheating! When installing the unit, make sure that heat dissipation and cooling are not obstructed.</p>

	⚠ CAUTION
	<p>Danger of tripping and falling! Make sure the unit does not present a danger of tripping!</p>

	⚠ DANGER
	<p>Electrical danger! Before beginning work on the unit or system, the following measures must be carried out:</p> <ul style="list-style-type: none"> - Deenergize. - Secure against being switched on again. - Determine whether deenergized. - Ground and short-circuit. - Cover or block off adjacent energized parts.

	⚠ DANGER
	<p>Electrical danger! The electrical connection may be carried out by trained and authorized electricians only!</p>

6 Operation trial

When you take operation trial, please ensure inlet pressure or outlet pressure is the same as the one shown on the name plate. If pressure needs to be changed, please adjust safety valve and notice the current load of motor. Inlet temperature must be kept within safety range (The highest inlet temperature of our standard roots blower is 50), if the inlet temperature is higher than 50 , °C °C please contact with us.

Please check the following items one by one while taking operation trial

- (1) Is rotating direction of the blower correct?
- (2) Is there any unusual noise?
- (3) To notice vibration situation of the blower
- (4) After operation trial, turn off the power to see if the blower can stop naturally.
- (5) Please check motor wire connection is correct voltage

If all above inspection are no problem, the formal operation can be arranged. At normal operation, there won't be too much maintenance, just pay attention on bearings and lubrication of gear.

	⚠ CAUTION
	<p>Danger of crushing from unit tipping over! In the unmounted state, the unit can easily tip due to its weight distribution! Wear gloves and safety shoes! Handle the unit with the appropriate care!</p>

	⚠ WARNING
	<p>Electrical danger! The pump-motor unit must be installed so that the electrical device cannot be damaged by external influences! In particular, the feed pipes must be securely routed, e.g. in cable ducts or in the floor.</p>

	⚠ CAUTION
	<p>Danger of damage to the pump-motor unit due to overheating! When installing the unit, make sure that heat dissipation and cooling are not obstructed.</p>

	⚠ CAUTION
	<p>Danger of tripping and falling! Make sure the unit does not present a danger of tripping!</p>

	⚠ DANGER
	<p>Electrical danger! Before beginning work on the unit or system, the following measures must be carried out:</p> <ul style="list-style-type: none"> - Deenergize. - Secure against being switched on again. - Determine whether deenergized. - Ground and short-circuit. - Cover or block off adjacent energized parts.

	⚠ DANGER
	<p>Electrical danger! The electrical connection may be carried out by trained and authorized electricians only!</p>

7 Safety valve adjustment

The Roots Blower with safety valve has been adjusted according to customer's specification before delivery. In order to make sure blower and motor are safe, please double check safety valve is releasing pressure accurately before operation. If safety valve is not working as setted pressure or already changed necessary pressure, please adjust safety valve again.

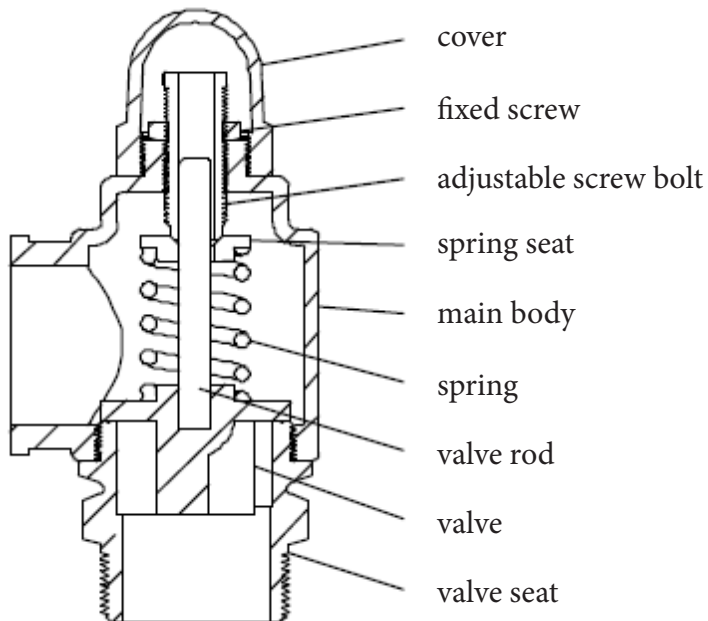

- The adjustment steps are shown as following:

- (1) Loose the valve cover
- (2) Loss the fixed screw nut
- (3) Adjust by operation pressure
 1. Reducing the operation pressure: screw on
 2. Increasing the operation pressure: screw off
- (4) Accuracy test: if the safety valve releases the pressure at specific pressure
- (5) Tighten the fixed screw nut
- (6) Tighten the cover of safety valve
- (7) Double test the accuracy of safety valve for pressure release

8 Maintenance

- Shaft seal

We use labyrinth type shaft seal for all our standard roots blowers, this shaft seal is not impact / touch directly with blower body, so it is not necessary to maintenance especially when blower is in normal operation.

- Lubrication

(1) Gear oil changing time

Replace gear oil (drain old gear oil in advance, then fill up new gear oil)

First time: after 700 hours operation (About 30 days)

Future: after first time of replacing, the future replacing period is as following:

Operating Pressure	Oil Replacing Period
Below 400 mbar (4000mmAq)	Once every 1 years
Above 400 mbar (4000mmAq)	Once every 6 month

Please use full-synthetic gear oil if pressure is over than 0.6 kgf/cm² (6000mmAq). If ambient temperature is higher than 40 degree C, the period should be decreased half time.

(2) Volume of lubrication

Please check oil level anytime to have blower life longer. Please refer to the following oil volume and check oil gauge on oil box, the best volume is at middle line of oil gauge (please do not higher than 2/3 level) when blower stop running. If oil is too full, oil will overflow from the overflow orifice. If oil is too full to overflow, please clean the blower surface and dry the oil on the ground. After one hour, double check the drain plug is locked well and no leakage.

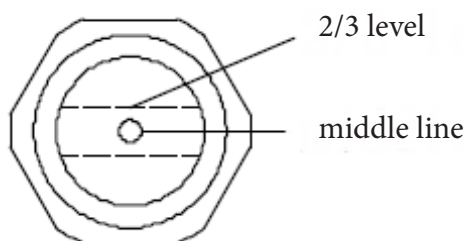

Model	Gear Oil Volume	Bearing (on driving side)
INW R40 – INW R45	850 ml	Using Sealed Bearing, No need to maintain
INW R50 – INW R60	2150 ml	
INW R65 – INW R80	2450 ml	
INW R90 – INW R125	5700 ml	
INW R150 – INW R160	11700 ml	

Lubricating oil

Suggest to use LUBOL CLP 220 (or same level) gear oil #150 - #220 (use for suction temperature is less than 50 °C).

Typical Physical Characteristics	Industrial Gear Oils
Flash Point COC, min.:	222 °C
Density at 20°C:	850 - 910 kg/m ³
Kinematic Viscosity at 40°C:	198 - 242 mm ² / s
Oxidizing properties:	Does not have
Pour Point, max.:	-15 °C

Inspection

(1) Daily

Pressure of suction port and discharge port in normal
 Load electric current of motor in normal
 Noise in normal
 Oil level in normal

(2) Monthly

Clean air filter in suction silencer
 Vibration in normal
 Lubrication oil level in normal
 Make sure no oil leakage

(3) Semiyearly

Check sound of bearing, gear and lobes are in normal.

I Repair and replacement

With normal maintenance, the blower's life can be extended longer. In order to keep blower's life longer, some parts are requested to repair or replacement in time when parts are damaged.

The replacement of wear items including, but not limited to, seals, bearings, couplings, exhaust cover gaskets, oil drain plugs, oil fill plugs etc., made in connection with normal service are not covered by this Warranty.

Replacement of bearings is required every 36 months. The minimum service life of bearings is 15,000 operating hours, providing the operating conditions are respected.

(1) Gear

To make appropriate marks of recover when disassembling, this is to ensure the parts can be recovered to right angle and position as original when re-assembling and to prevent lobes impact each other. If possible, please send damaged parts and blower for repair, because the synchronization of gear and lobes are higher technical working.

(2) Bearing

In case to damage gear and lobes, please change new bearing if bearing is in abnormal condition.

Blower Model	Bearing model (on driving side)	Bearing model (one gear side)	Replacement Time
INW R40 – INW R45	6204LLU	6204ZCM	every 3 year
INW R50 – INW R60	6306LLU	6306ZCM	every 3 year
INW R65 – INW R80	6207LLU	6207ZCM	every 3 year
INW R90 – INW R125	6309LLU	6309ZCM	every 3 year
INW R150 – INW R160	6312LLU	6312ZCM	every 3 year

Note: Replace lubrication oil timely is able to extend operating life longer.

(3) Coupling Rubber

Blower Model	Bearing model(on driving side)
INW R40 – INW R60	HRC70
INW R65 – INW R80	HRC90
INW R90 – INW R125	HRC110
INW R150 – INW R160	HRC130

(4) Recommended interval of time for spare parts replacement.

(pic. page 17, Construction and Spare Parts)

No.	Item	Need q'ty each time	Suggestion Replacement Time
12	Gear	2	every 5 year
7	Bearing	4	every 3 year
17	Packing	1	when change bearing
20	Oil gauge	1	every 2 years
2	Coupling	1	every 3 year
25	Pressure gauge	1	every year (depends on situation)
23	Inlet Silencer Air Filter	1	every 6 - 12 months (depends on situation)

9 Troubleshooting

Blower is not running	
Possible reasons for failure:	Solution:
Electrical wiring / lines error	Overhaul the electrical wiring / line
Motor is defective	Overhaul the motor
Foreign matter fall into the cylinder	Clean foreign matter away
Rotor get rust	Clean rust away
Gear is stuck by foreign matter	Clean foreign matter away
Inlet / outlet pipe line is clogged by foreign matter	Clean foreign matter away or open inlet / outlet valve
Outlet temperature is over heating	
Possible reasons for failure:	Solution:
Gear oil level is too over	Discharge oil to appropriate level
Filter is too dirty	Clean or change a new filter
Pressure difference is too big	Find out reason and reduce pressure difference
Ambient temperature is too high	Install cooling system
Indoor air is poor circulation	Open the door or window
Rotor clearance is eccentric	Sent to plant to adjust rotor clearance
Bearing temperature is too high	
Possible reasons for failure:	Solution:
Oil level is too high	Discharge oil to standard level
Inappropriate lubricating oil	Change appropriate oil
Operating pressure is too over	Adjust pressure
Inlet gas is changed	Find out the reason and improve it
Bearing is worn	Sent to plant to change a new one
Bearing shaft is worn	Sent to plant to change a new one
Rotor temperature rise	Find out the reason and improve it
Gear oil temperature is too high	
Possible reasons for failure:	Solution:
Lubricating oil volume is too over or less	Fill or discharge oil to appropriate level
Inappropriate lubricant viscosity	Change appropriate oil
Gear is worn	Sent to plant to change a new one
Gear clearance is too over	Sent to plant to change a new one

Current is overload	
Possible reasons for failure:	Solution:
The anti-pipeline group of inlet/outlet is increased, to cause large pressure difference	Find out the reason and improve it
Blower speed is increased	Reduce Blower speed
Motor is breakdown	Overhaul the motor
Rotor get rust	Clean the rust away
Foreign matter fall into the cylinder	Clean the foreign matter away
Rotors impact each other	Sent to plant for adjusting gap
Rotor and cylinder wall impact each other	Sent to plant for adjusting gap
Unnatural noise	
Possible reasons for failure:	Solution:
Rotor and rotor impact each other	Sent to plant for adjusting gap
Rotor and cylinder wall impact each other	Sent to plant for adjusting gap
Gear is worn or jammed by foreign matter	Sent to plant to clean foreign matter away
Foreign matter fall into the cylinder	Clean foreign matter away
Coupling rubber is broken	Change a new coupling rubber
Bearing is worn	Sent to plant to change new bearing

10 Construction and Spare Parts

Spare Parts

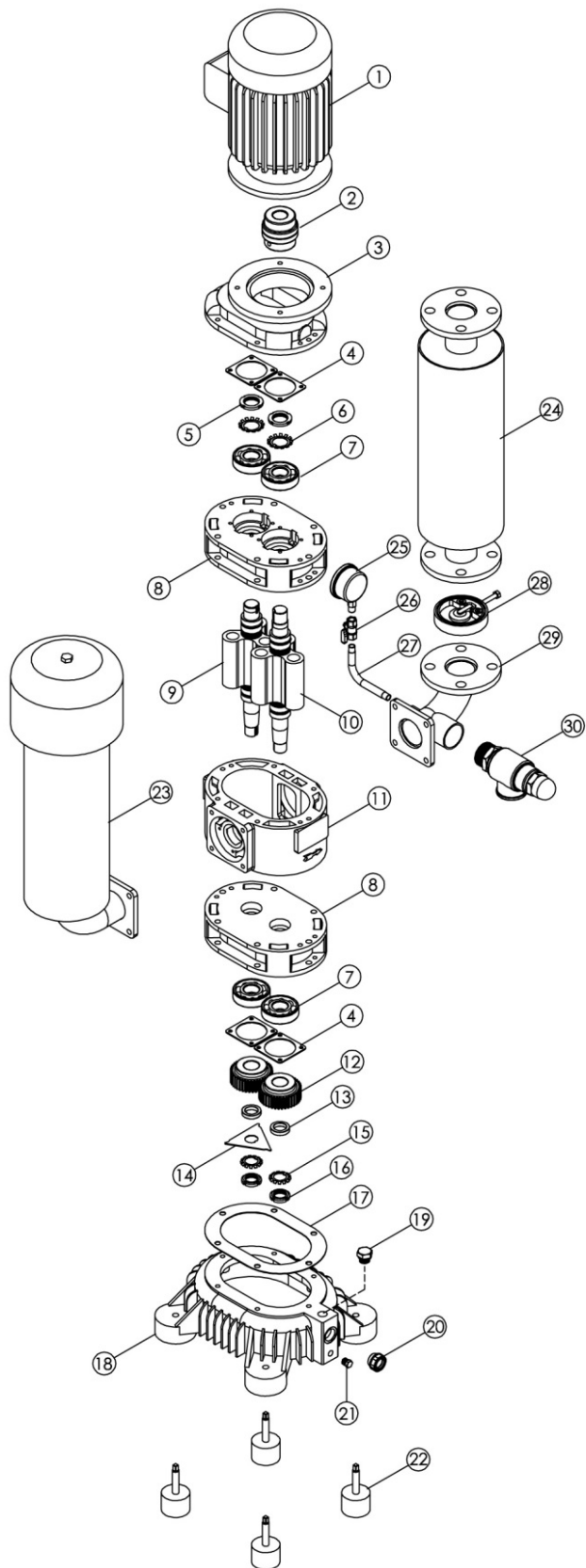

No.	Item	Qty
1	Motor	1
2	Coupling	1
3	Motor base	1
4	Bearing washer	4
5	Nut	2
6	Washer	2
7	Bearing	4
8	Bearing base	2
9	Rotor	1
10	Rotor	1
11	Main casing	1
12	Gear	2
13	Washer	2
14	Oil splash	1
15	Washer	2
16	Nut	2
17	Packing	1
18	Oil case	1
19	Oil plug	1
20	Oil gauge	1
21	Drain plug	1
22	Vibration isolator	4
23	Inlet silencer	1
24	Outlet silencer	1
25	Pressure gauge	1
26	Ball valve	1
27	Elbow joint	1
28	Check valve	1
29	Elbow joint	1
30	Relief valve	1

INECO

IN-ECO, spol. s r.o.
Radlinského 13
Ružomberok, 034 01
T +421 44 430 46 62
F +421 44 430 46 63
E: info@in-eco.sk
www.in-eco.eu