

Zračne linearne pumpe Alita (Membranska puhala)



- 1.1_Standardni modeli
- 1.2_Modeli na tlak i vakuum
- 1.3_Oem serija pumpa



INECO

**Air and Vacuum
Components**

www.in-eco.hr

1

Zračne linearne pumpe Alita (Membranska puhala)

Zračne linearne pumpe Alita predstavljaju učinkoviti izvor komprimiranog zraka. Zahvaljujući svojoj konstrukciji pumpe proizvode nisku razinu buke i odlikuju se niskom potrošnjom električne struje. Strujanje zraka nastaje uslijed vibriranja elastičnih membrana (1) koje su ugrađene (2) u kapama sa jednosmjernim ventilima (3). Kretanje permanentnog magneta (4) na kome su membrane pričvršćene, izazvano je djelovanjem naizmjeničnog magnetnog polja koje je generirano parom elektromagnetskih namota (5). Cijeli proces funkcionira učinkovito, bez mehaničkog trenja i s niskom razinom buke.

Karakteristika:

- > tečan protok zraka
- > niska razina buke i vibracija
- > visoka učinkovitost
- > niska potrošnja električne energije
- > dugi radni vijek
- > postrojenja bezuljne izvedbe
- > kompaktna i laka konstrukcija
- > jednostavno održavanje
- > toplotna zaštita
- > mogućnost primjene u vanjskoj i unutarnjoj sredini
- > pouzdani rad (isprekidani i kontinuirani)
- > sigurna konstrukcija
- > automatsko utvrđivanje kvarova membrana

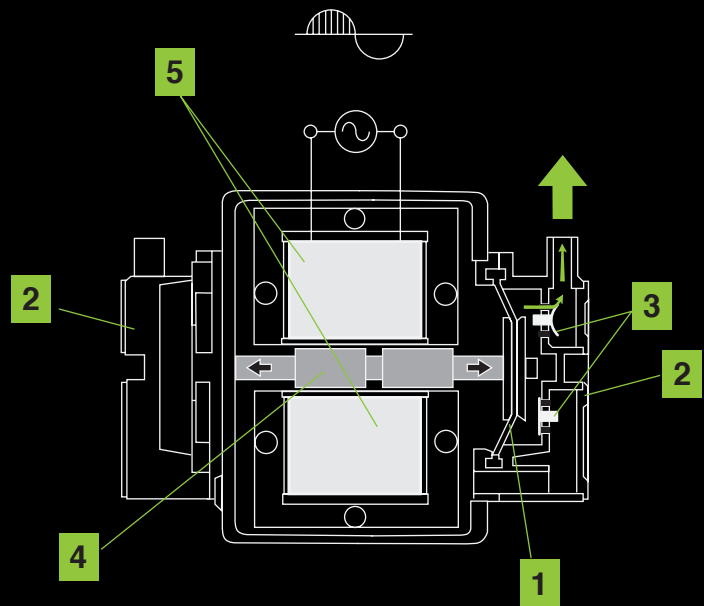

1

Zračne linearne pumpe Alita (Membranska puhalo)

—

1.1 Standardni modeli

1

Zračne linearne pumpe Alita (Membranska puhalo)

—

1.1 Standardni modeli

ALITA_ Zračne linearne pumpe

Standardni modeli AL-40, AL-60, AL-80

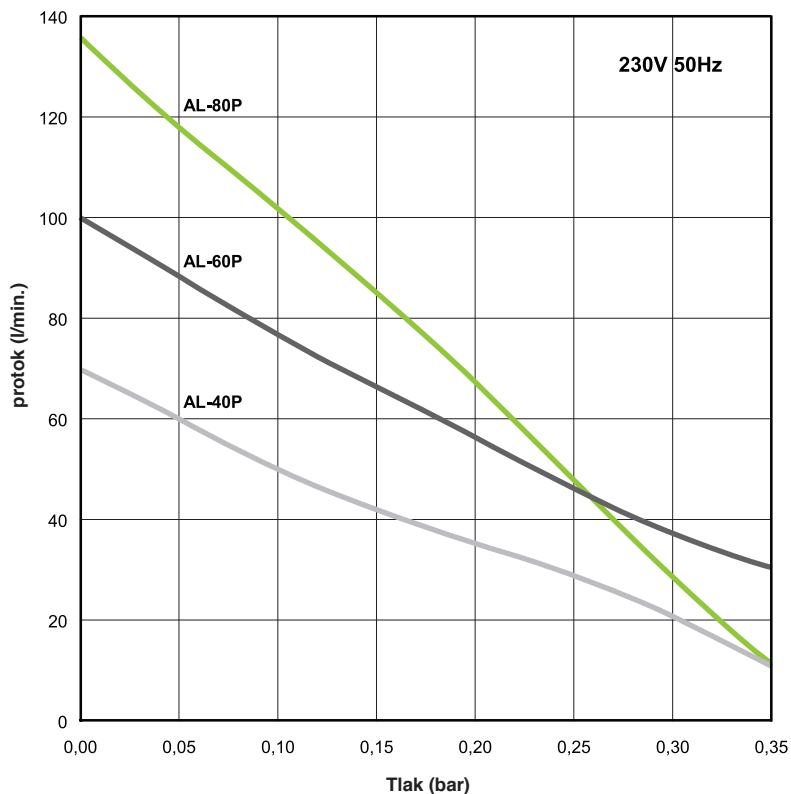

Model	AL-40	AL-60	AL-80
Maks. snaga	48 W	72 W	86 W
Razina buke	36 dB	38 dB	39 dB
Težina	5.6 kg	6.5 kg	6.5 kg
Izlaz ø	18 mm		
Maks. radni tlak	220 mbar		
Snaga (Maks. radni tlak)	40 W	50 W	52 W
Napon, frekvencija	230V 50Hz		
Stupanj zaštite IP	IP54		
Dimenzije D x Š x V	205 mm x 173 mm x 202 mm		

Jednofazni uređaji su predloženi s +/- 10% dozvoljenim odstupanjem. Prezentirane informacije temelje se na rezultatima testova za nominalnu jedinicu. Specifikacija je predmet izmjene bez upozorenja.

ALITA_ Zračne linearne pumpe

Standardni modeli **AL-100, AL-120, AL-150, AL-200**

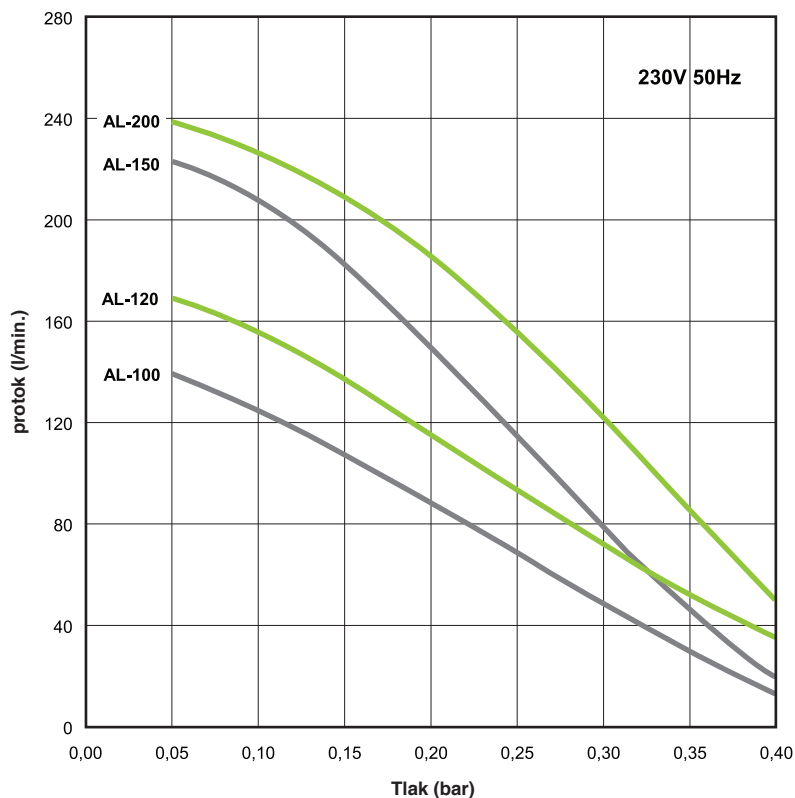

Model	AL-100	AL-120	AL-150	AL-200
Maks. snaga	120 W	124 W	160 W	261 W
Razina buke	41 dB	42 dB	44 dB	45 dB
Težina	8.3 kg	8.3 kg	10.1 kg	10.1 kg
Izlaz ø	18 mm		26 mm	
Maks. radni tlak	260 mbar			
Snaga (Maks. radni tlak)	78 W	97 W	110 W	125 W
Napon, frekvencija	230V 50Hz			
Stupanj zaštite IP	IP54			
Dimenzije D x Š x V	248 mm x 205 mm x 245 mm			

Jednofazni uređaji su predloženi s +/- 10% dozvoljenim odstupanjem. Prezentirane informacije temelje se na rezultatima testova za nominalnu jedinicu. Specifikacija je predmet izmjene bez upozorenja.

ALITA_ Zračne linearne pumpe

Standardni modeli AL-250, AL-300, AL-400

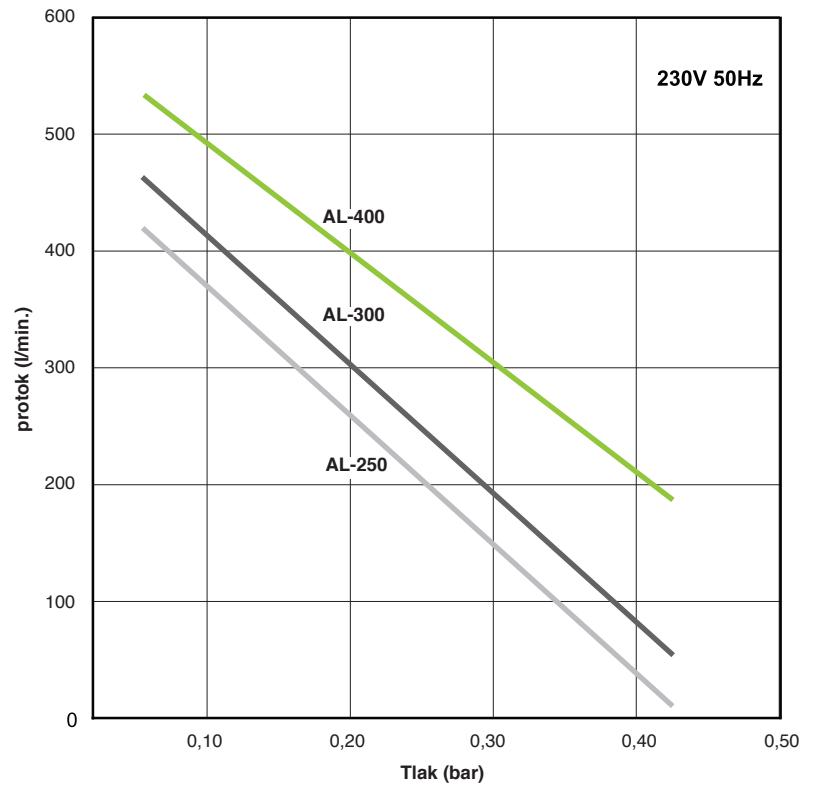

Model	AL-250	AL-300	AL-400
Maks. snaga	240 W	290 W	440 W
Razina buke	46 dB	47 dB	49 dB
Težina	18,8 kg	22,1 kg	22,2 kg
Izlaz ϕ	30 mm		
Maks. radni tlak	260 mbar		
Napon, frekvencija	230V 50Hz		
Stupanj zaštite IP	IP54		
Dimenzije D x Š x V	420 mm x 248 mm x 262 mm		

Jednofazni uređaji su predloženi s +/- 10% dozvoljenim odstupanjem. Prezentirane informacije temelje se na rezultatima testova za nominalnu jedinicu. Specifikacija je predmet izmjene bez upozorenja.

1

Zračne linearne pumpe Alita (Membranska puhala)

1.1

Modeli na tlak i vakuum

ALITA_ Zračne linearne pumpe

Modeli na tlak AL-6A, AL-15A



Modeli na tlak i vakuum AL-6SA, AL-15SA

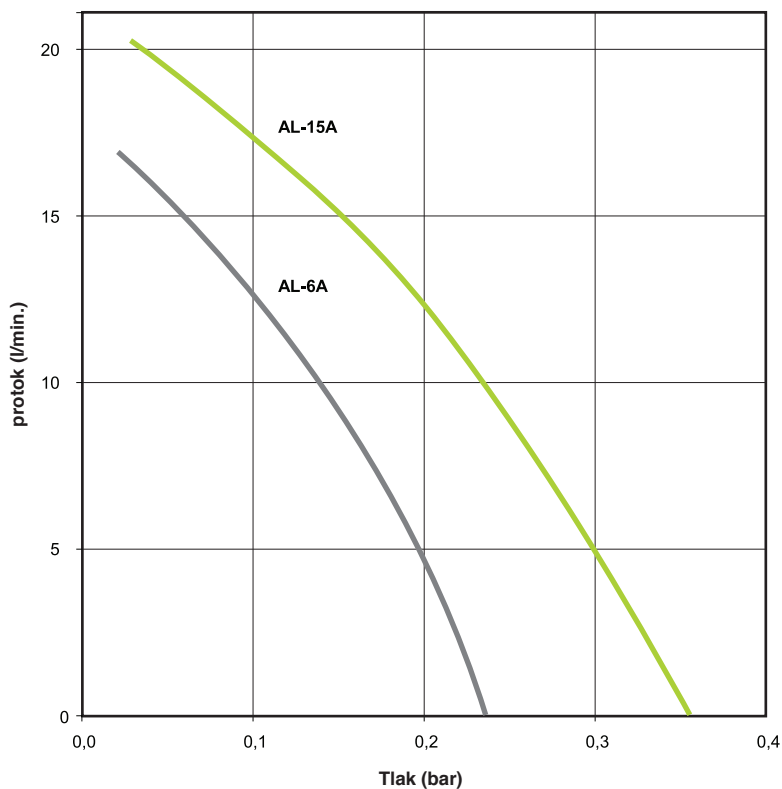

Model	AL-6A/AL-6SA	AL-15/AL-15SA
Struja	0,1 A	0,2 A
Snaga	13 W	26 W
Razina buke	27 dB	29 dB
Težina	2,4 kg	2,4 kg
Maks. radni tlak	100 mbar	
Dimenzije D x Š x V	150 mm x 130 mm x 111 mm	
Napon, frekvencija	230V 50Hz	
Stupanj zaštite IP	IP54	

Jednofazni uređaji su predloženi s +/- 10% dozvoljenim odstupanjem. Prezentirane informacije temelje se na rezultatima testova za nominalnu jedinicu. Specifikacija je predmet izmjene bez upozorenja.

ALITA_ Zračne linearne pumpe

Modeli na tlak i vakuum AL-40SA, AL-60SA, AL-80SA

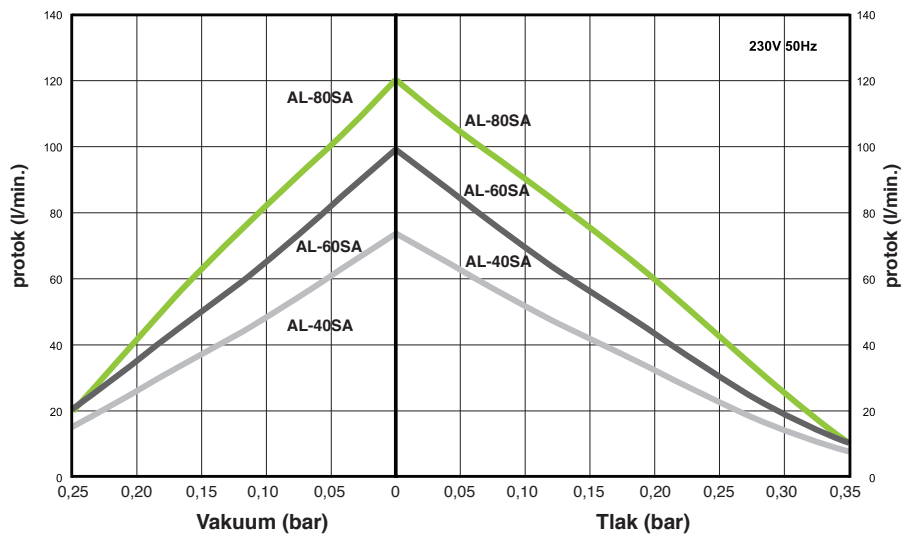

Model	AL-40SA	AL-60SA	AL-80SA
Maks. snaga	48 W	72 W	86 W
Razina buke	36 dB	38 dB	39 dB
Težina	5.6 kg	6.5 kg	6.5 kg
Izlaz ϕ	1/4" FPT		
Maks. radni tlak	210 mbar		
Maks. radni vakuum	150 mbar		
Maks. snaga (Maks. radni tlak)	40 W	50 W	52 W
Napon, frekvencija	230V 50Hz		
Stupanj zaštite IP	IP54		
Dimenzije D x Š x V	205 mm x 173 mm x 202 mm		

Prezentirane informacije temelje se na rezultatima testova za nominalnu jedinicu. Specifikacija je predmet izmjene bez upozorenja.

1

Zračne linearne pumpe Alita (Membranska puhala)

—

1.1 OEM Serija pumpa

1

Zračne linearne pumpe Alita (Membranska puhala)

1.1 OEM Serija pumpa

ALITA_ Zračne linearne pumpe

OEM Serija pumpa

strana 1 z 2

Pored širokog asortimana standardnih modela pumpi koje se također mogu koristiti, nudimo originalne uređaje proizvođača (OEM) - puhala & vakuumske pumpe, prilagođene membranske kompresore za industriju za razne namjene.

AL-6B
AL-15B
AL-20B

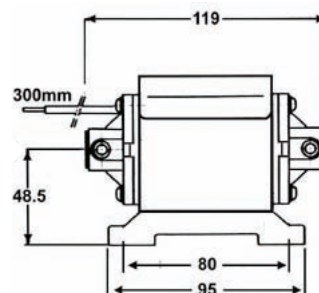
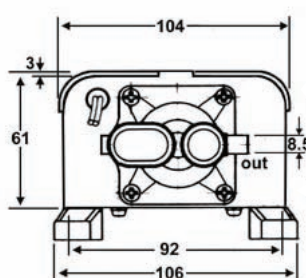

AL-6SB
AL-15SB
AL-20SB

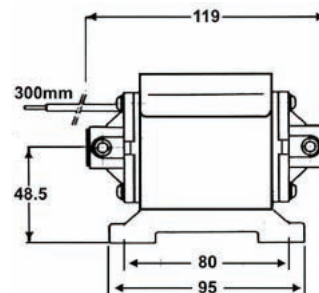
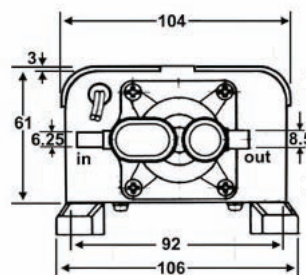

AL-30B
AL-40B
AL-50B

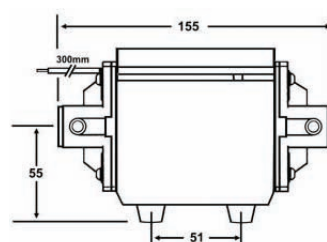
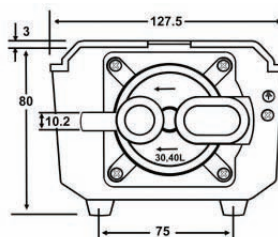

AL-30SB
AL-40SB
AL-50SB

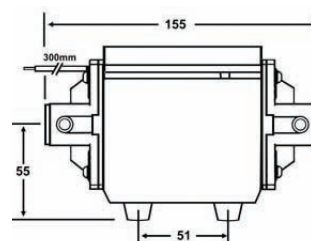
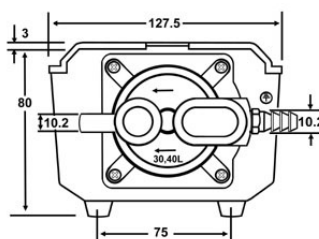

ALITA_ Zračne linearne pumpe
OEM Serija pumpe

strana 2 z 2

AL-60B

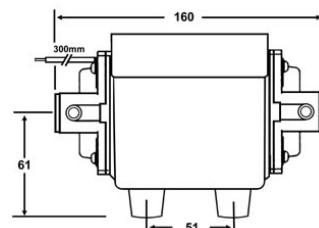
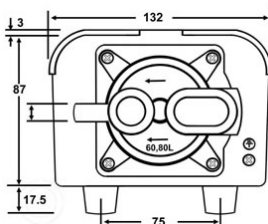

AL-60SB

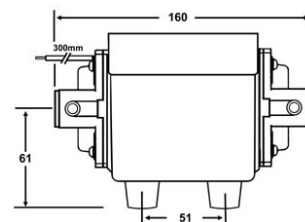
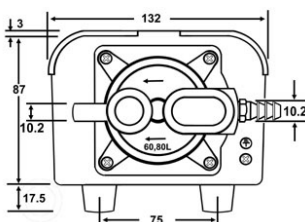

AL-80B
AL-100B
AL-120B



Tlačno priključenje: 15mm (2x)
Razmjeri: 133x175x105 mm

AL-80SB
AL-100SB
AL-120SB



Tlačno priključenje: 15mm (2x)
Vakuum priključenje: 10mm
Razmjeri: 133x175x105 mm

INECO

IN-ECO, spol. s r.o.
Radlinského 13
034 01 Ružomberok
Slovačka Republika
T +421 44 4304662
F +421 44 4304663
E info@in-eco.hr
www.in-eco.hr

19.11.2018